





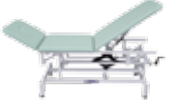

























Table of contents

JORDAN physiotherapeutic couch	page
A line:     A1 A3 AS A wood	4, 5
D line:    D1 D2 D3	6, 7
B line:     B2 B3 B2 prima B3 prima	8, 9
F line:     F2 F3 F4 F5	10, 11
G line:    G3 G5 G6 plus	12, 13
U line:        U2 U3 U4 U5 U6 U7 U7 exclusiv	14, 15
JORDAN couch designed for the Vojta method	
E line:    E1 E2 E box	16, 17

JORDAN traction and tilting couches

ME line:



ME2



ME3

18, 19

C line:



C1

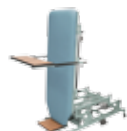

C2

18, 19

JORDAN special couches



Simple 2



Simple 3



Prima 3



M6 osteo

21



F7 CM



A transport



Hospital

22



U7 plastik



T3 transfuze



T3 transfuze simplel

23

Holzmassageliegen JORDAN



HENRY



MARY

24

Untypical modifications, hygienic mats, disinfectants

25

Optional accessories for JORDAN couches

26

Colours chart for JORDAN couches

27

If you purchase our new RESI couches we will arrange for environment-friendly disposal of your old beds.



JORDAN physiotherapeutic couch, A line



JORDAN A line – actuator-free couches with fixed height.

All model of this line are made at a standard height of 60 cm, but you may change this fixed height in your purchase order. Simple but solid structure guarantees high stability. Leveling screws can compensate for floor unevenness.

The headrest can be adjusted either by a system of A1 levers or by an A3 and AS gas strut.

JORDAN AS is the ideal solution for multi-purpose rooms where you can fold out the bed from the wall whenever it is needed.

It is one of the most simply constructed couches on the market.. It has a broad field of application as an examination table in medical practitioner and specialist doctor surgeries, as massage tables or relaxation couches in spas, welfare institutions and sport centres.

JORDAN A1

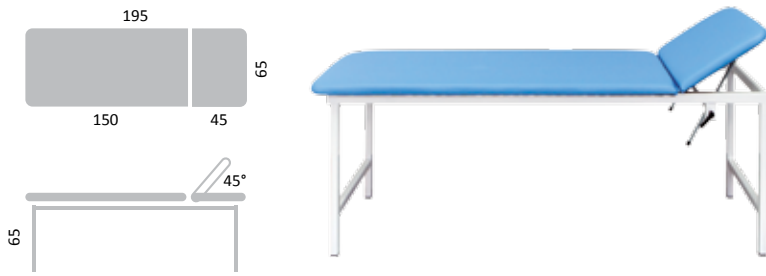

JORDAN AS



JORDAN A3

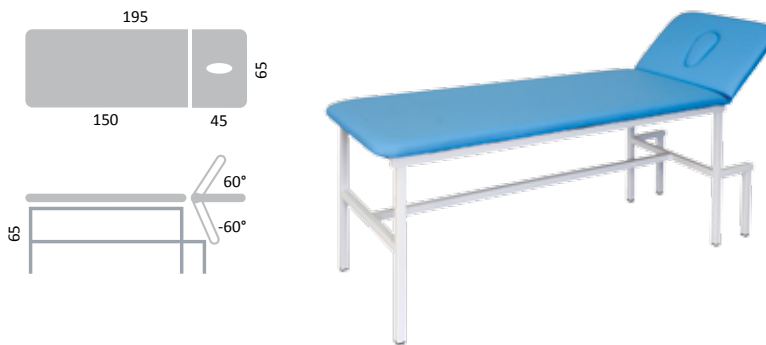

JORDAN A wood

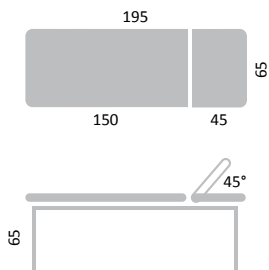

natural version



mahogany version with shelf

TECHNICAL PARAMETERS

Basic design of the JORDAN A line of couches	A1	A3	AS	A wood
dimensions, length x width (cm)	195 x 65	195 x 65	200 x 60	195 x 65
fixed height, alteration at no extra charge (cm)	60	60	60	65
number of cushioned segments	2	2	2	2
mouth opening in bolster with cover	•	yes	yes	-
head end adjustable by Rostomat system	yes	-	yes	yes
head end adjustable by gas strut	-	yes	-	-
optional location of head part (by wall or vice-versa)	-	-	yes	-
Optional accessories:				
ø 70 mm castors with brake	•	•	-	-
mouth opening in bolster with cover	•	x	x	-
halved leg section adjustable by gas strut	•	•	-	-
extended bed width over 80 cm inclusive	•	•	•	-
storage shelf	•	•	--	•
sanitary paper holder	•	•	•	-

x basic design

• extra orders possible

- not available

JORDAN physiotherapeutic couch, D line



JORDAN D line – actuator-free couches with manual height adjustment using a lever mechanism.

The height of all the models can be adjusted manually using a built-in lever by the patient's feet. The adjustment range is from 65 to 85 cm. Base width of 100 cm for model D1 can be changed on request at no extra cost in the range of 70 to 100 cm.

These couches are recommended in particular for places where the service staff rotates, for example different massagers working with the same bed. This bed can be adjusted to individual height. Depending on your needs you may choose from three basic models as well as from a number of accessories.

This line is recommended for massages in spas, physiotherapy or sport centres, where it is used by more than one massager.

JORDAN D1

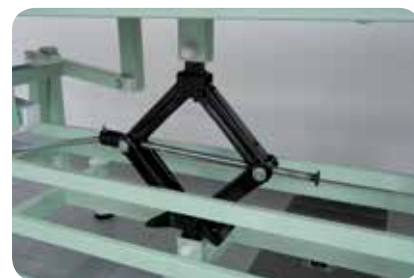
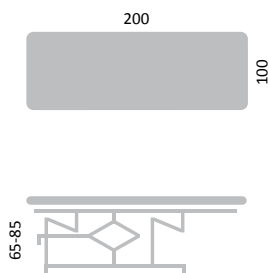

lever mechanism

JORDAN D2

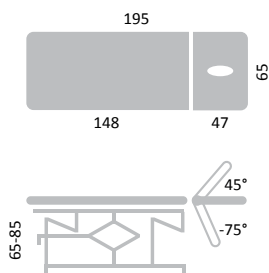

3-part head bolster

JORDAN D3

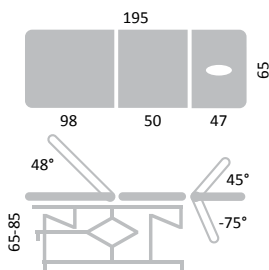

castors – diameter 100 mm



conical narrowing

TECHNICAL PARAMETERS

Basic design of the JORDAN D line of couches

	D1	D2	D3
dimensions, length x width (cm)	195 x 70 - 100 <i>as required</i>	195 x 65	200 x 65
manually adjustable height (cm)	65 - 85	65 - 85	65 - 85
number of cushioned segments	1	2	3
mouth opening in bolster with cover	•	yes	yes
head end adjustable by gas strut	-	yes	yes
leg position adjustable by gas strut	-	•	yes
Optional accessories:			
castors - diameter 70 mm or 100 mm	•	•	•
3-part head bolster	-	•	•
mouth opening with cover	•	x	x
extended bed width over 80 cm inclusive	x	•	•
conical narrowing at the foot end	-	•	•
conical narrowing at the head end	-	•	•
fixation pins - shoulder, between legs	•	•	•
sanitary paper holder	•	•	•
	<i>x basic design</i>	<i>• extra orders possible</i>	<i>- not available</i>

JORDAN physiotherapeutic couch, B line



JORDAN B line – single-actuator couches with a simple construction and electric height adjustment in the bed axis..

The couch may be adjusted by electric drive at a range from 55 to 95 cm with the patient lying on the bed. Models B2 and B3 are easy to handle due to their light weight and castors. The couches are suitable for classic massages or simple exercises with a physiotherapist.

The area of application is very broad. The disadvantage of this line is that it is less stable in the top position and its lower safe working load (150kg).

By selecting the B2 prima or B3 prima couches you can acquire a couch which is adjustable in the couch axis and can be equipped with castors and an in-built actuator control unit.

JORDAN B2

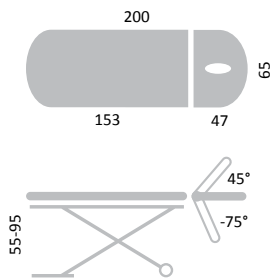

manually adjustable height

JORDAN B3

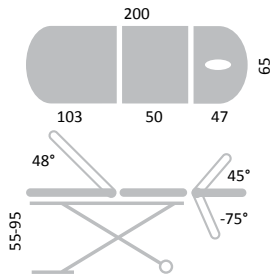

electric foot control unit

JORDAN B2 prima

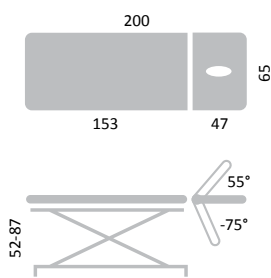

castors – diameter 100 mm

JORDAN B3 prima

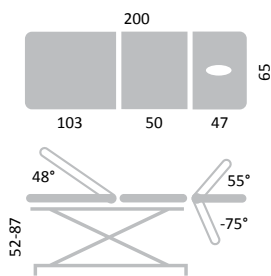

sanitary paper holder

TECHNICAL PARAMETERS

Basic design of the JORDAN B line of couches

	B2	B3	B2 prima	B3 prima
dimensions, length x width (cm)	200 x 65	195 x 65	200 x 65	200 x 65
number of cushioned segments	2	3	2	3
mouth opening in bolster with cover	yes	yes	yes	yes
head end adjustable by gas strut	yes	yes	yes	yes
leg position adjustable by gas strut	-	yes	-	yes
electric height adjustment (cm)	55 - 95	55 - 95	52 - 87	52 - 87
manually adjustable height	yes	yes	yes	yes

Optional accessories:

castors - diameter 70 mm or 100 mm	-	-	•	•
3-part head bolster	•	•	•	•
fixation pins - shoulder, between legs	•	•	•	•
conical narrowing at the head end	•	•	•	•
electric foot control unit	•	•	•	•
RAL or chrome electric built-in control unit	-	-	•	•
extended bed width over 80 cm inclusive	•	•	•	•
sanitary paper holder behind head end	•	•	•	•
additional folding rests along the central part of the couch	•	•	•	•
safety switch-off cabinet	•	•	•	•

x basic design

• extra orders possible

- not available

JORDAN physiotherapeutic couch, F line



JORDAN F line - single-actuator couches with a stabile construction and electrically adjustable height.

The F line offers the basic model of a professional couch in a new elegant design. The structure is stable in all therapeutic positions and heights with a lifting range from 50 to 105 cm with a patient lying on the couch. The lower position enables disabled and older people easy access to the couch.. The couch positions can be easily and quietly adjusted during therapy. This product line has a broad area of application.

Beds can be used for examinations, massages, physiotherapy. In addition, they can be used for simple surgical procedures. You can customize your bed to meet your needs by selecting from a broad portfolio of accessories.

JORDAN F2

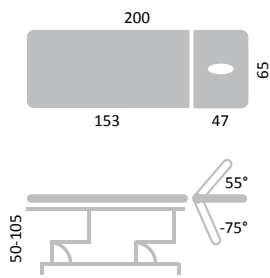

gas strut for adjustment of foot end

JORDAN F3

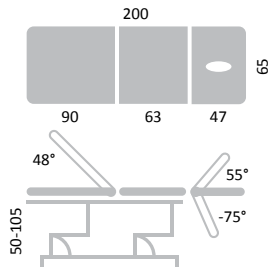

3-part head bolster

JORDAN F4

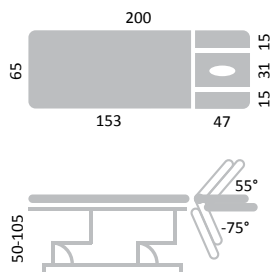

additional folding rests

JORDAN F5

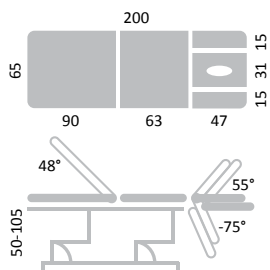

TECHNICAL PARAMETERS

Basic design of the JORDAN F line of couches

	F2	F3	F4	F5
dimensions, length x width (cm)	200 x 65	200 x 65	200 x 65	200 x 65
number of cushioned segments	2	3	4	5
3-part head bolster	-	-	yes	yes
mouth opening in bolster with cover	yes	yes	yes	yes
head end adjustable by gas strut	yes	yes	yes	yes
leg position adjustable by gas strut	-	yes	-	yes
electric height adjustment (cm)	50 - 105	50 - 105	50 - 105	50 - 105
manually adjustable height	yes	yes	yes	yes

Optional accessories:

castors - diameter 70 mm or 100 mm	•	•	•	•
fixation pins - shoulder, between legs	•	•	•	•
conical narrowing at the foot end	•	•	•	•
conical narrowing at the head end	•	•	•	•
electric foot control unit	•	•	•	•
RAL or chrome electric built-in control unit	•	•	•	•
extended bed width over 80 cm inclusive	•	•	•	•
sanitary paper holder behind head end	•	•	•	•
RAL or chrome side bars for fixation belts	•	•	•	•
euro-bar along bed side	•	•	•	•
fixation hinge for stainless steel Euro-track, tilting universal	•	•	•	•
additional folding rests along the central part of the couch	•	•	•	•
safety switch-off cabinet	•	•	•	•

x basic design

• extra orders possible

- not available

JORDAN physiotherapeutic couch, G line



JORDAN G line – double-actuator couches of stable construction whose height can be adjusted and backrest altered to the drainage position electrically.

The G line offers a higher standard of professional couches with an elegant design. The construction is stable in all therapeutic positions and heights with a lifting range from 50 to 105 cm even with the patient lying on the couch. The lower position enables disabled and older people easy access to the couch. This product line is equipped with a second actuator for adjusting the bed to the drainage position for special physiotherapy. Bed positions can be easily and silently adjusted during therapy.

This product line has a broad area of application. The couches can be used for examinations, massages; they are highly suitable physiotherapeutic treatment for which they are specially designed. In addition they can be used for simple surgical procedures.

JORDAN G3

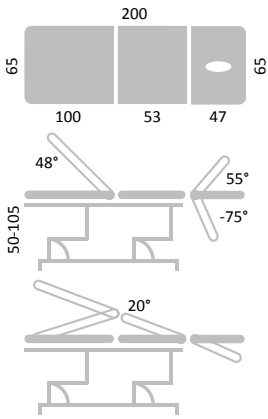

JORDAN G5

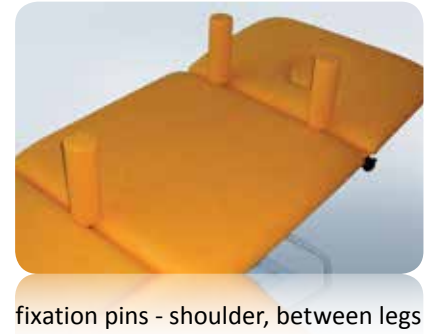
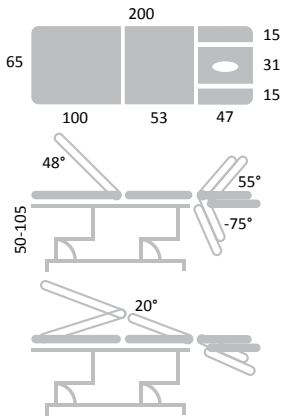

JORDAN G6 plus

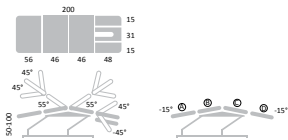

TECHNICAL PARAMETERS

Basic design of the JORDAN G line of couches

	G3	G5	G5 plus
dimensions, length x width (cm)	200 x 65	200 x 65	200 x 65
number of cushioned segments	3	5	6
3-part head bolster	-	yes	yes
mouth opening in bolster with cover	yes	yes	yes
head end adjustable by gas strut	yes	yes	yes
drainage position adjustable by actuator	yes	yes	yes
leg position adjustable by gas strut	yes	yes	yes
electric height adjustment (cm)	50 - 105	50 - 105	50 - 100
manually adjustable height	yes	yes	yes
Optional accessories:			
castors - diameter 70 mm or 100 mm	•	•	only ø 70 mm
fixation pins - shoulder, between legs	•	•	-
conical narrowing at the foot end	•	•	-
conical narrowing at the head end	•	-	-
electric foot control unit	•	•	•
RAL or chrome electric built-in control unit	•	•	•
extended bed width over 80 cm inclusive	•	•	-
sanitary paper holder behind head end	•	•	•
RAL or chrome side bars for fixation belts	•	•	-
euro-bar along bed side	•	•	-
fixation hinge for stainless steel Euro-track, tilting universal	•	•	-
additional folding rests along the central part of the couch	•	•	-
safety switch-off cabinet	•	•	•

x basic design

• extra orders possible

- not available

JORDAN physiotherapeutic couch, U line



JORDAN U line – double actuator couches of stable construction whose height can be adjusted and backrest altered to a U-shape electrically.

The individual models offer a line of physiotherapeutic beds designed for physiotherapists. The simple and accurate control using two to three electric actuators, or by a gas strut as required, enables adjustment to all positions applied in physiotherapy. Depending on the demands of your practice, you may choose from two to seven section beds. These beds are suitable for spa bath houses, welfare centres, physiotherapy and rehabilitation centres as well as for specialist doctor surgeries.

JORDAN U2

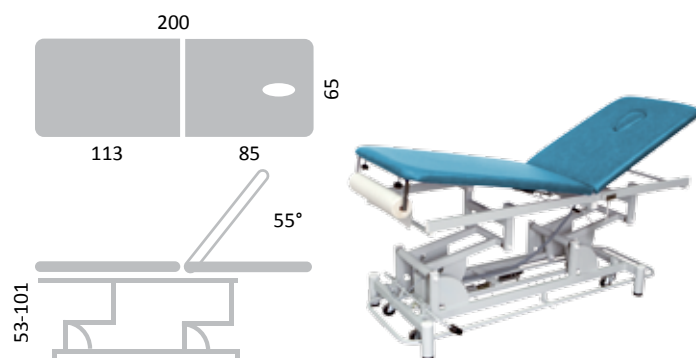

JORDAN U3

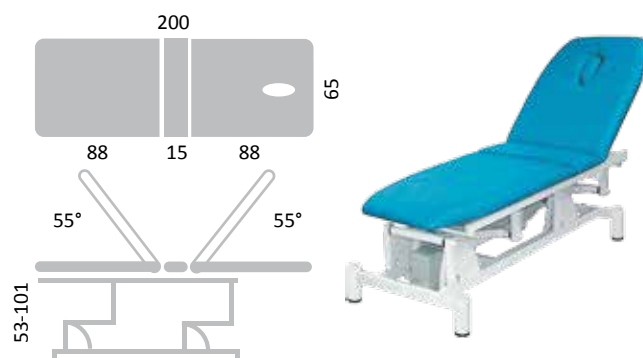

JORDAN U4

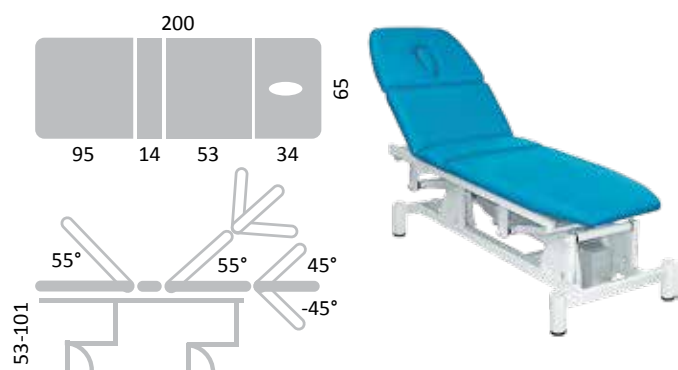

JORDAN U5

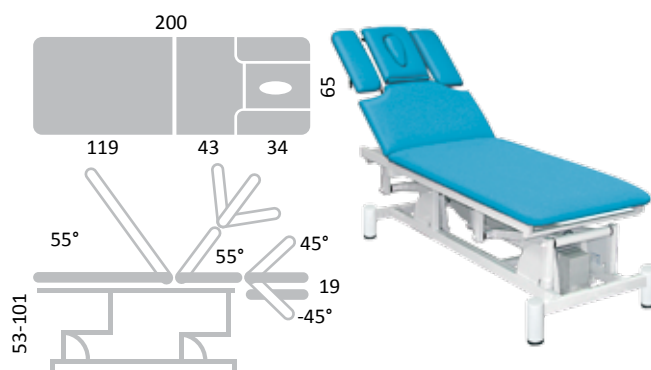

JORDAN U6

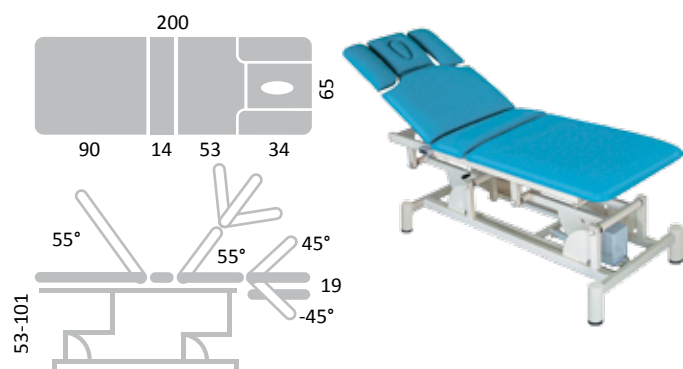

JORDAN U7

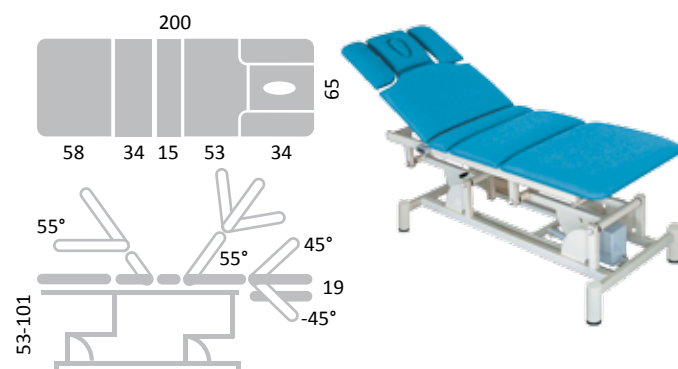

JORDAN U7 exclusiv

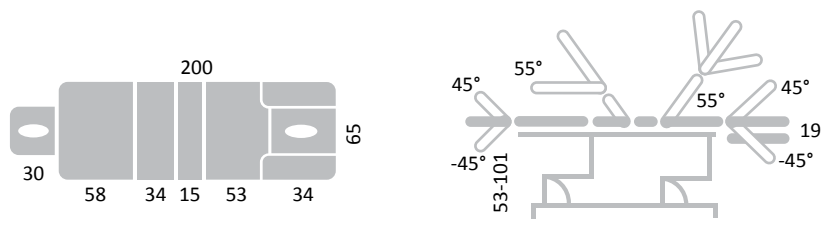

TECHNICAL PARAMETERS

Basic design of the JORDAN U line of couches

	U2	U3	U4	U5	U6	U7	U7 exclusiv
dimensions, length x width (cm)	198 x 65	198 x 65	198 x 65	198 x 65	198 x 65	198 x 65	198 x 65
number of cushioned segments	2	3	4	5	6	7	8
3-part head bolster	-	-	-	yes	yes	yes	yes
additional bolster	-	-	-	-	-	-	yes
mouth opening with cover	yes	yes	yes	yes	yes	yes	yes
folding armrests move with the backrest	-	-	-	yes	yes	yes	yes
backrest adjustable by actuator (for sitting)	yes	yes	yes	yes	yes	yes	yes
head end adjustable by gas strut	-	-	yes	yes	yes	yes	yes
leg position adjustable by gas strut	-	yes	yes	yes	yes	yes	yes
electric height adjustment (cm)	53 - 101	53 - 101	53 - 101	53 - 101	53 - 101	53 - 101	53 - 101
manually adjustable height	yes	yes	yes	yes	yes	yes	yes

Optional accessories:

castors - diameter 70 mm or 100 mm	•	•	•	•	•	•	•
fixation pins - shoulder, between legs	•	•	•	•	•	•	•
electric foot control unit	•	•	•	•	•	•	•
RAL or chrome electric built-in control unit	•	•	•	•	•	•	•
electrical foot end	•	•	•	•	•	•	•
sanitary paper holder behind head end	•	•	•	•	•	•	•
RAL or chrome side bars for fixation belts	•	•	•	•	•	•	•
euro-bar along bed side	•	•	•	•	•	•	•
fixation hinge for stainless steel Euro-track, tilting universal	•	•	•	•	•	•	•
additional folding rests along the central part of the couch	•	•	•	•	•	•	•
safety switch-off cabinet	•	•	•	•	•	•	•

x basic design

• extra orders possible

- not available

JORDAN couch, E line



ORDAN E line -single-actuator couch with electric height adjustment, specially designed for the Vojta method. The basic design for Vojta method offers a single-actuator bed with electric height adjustment. The construction is stable in all therapeutic positions and heights with a lifting range from 50 to 105 cm even with the patient lying on the bed. **At your request, we can reduce the minimum height of 30 cm. Stroke is then in the range of 30 to 87 cm.** The standard bed width is 100 cm, but you can extend it from 80 to 120 cm. Beds are used in particular in welfare centres for children, physiotherapeutic centres specializing in the Vojta method as well as in households for home exercises with child patients.

We also manufacture a simpler actuator-free JORDAN E folding box couch with fixed height for the Vojta method. The bed is delivered in a standard 100 cm width. You can specify the required height in the purchase order.

The mobile JORDAN E box is an ideal solution for smaller premises – apartments and multi-purpose rooms.

JORDAN E1

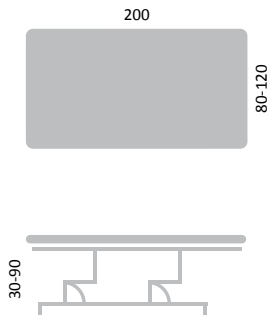

electric foot control unit

JORDAN E2

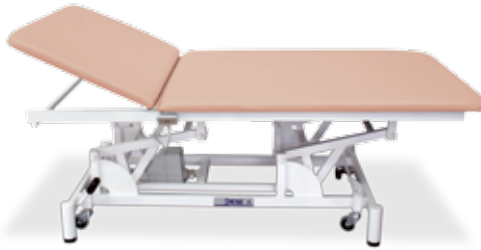
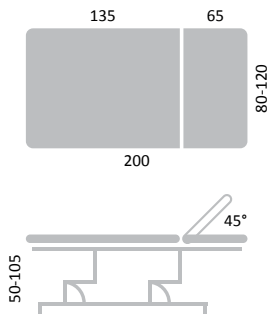

castors – diameter 100 mm

JORDAN E box

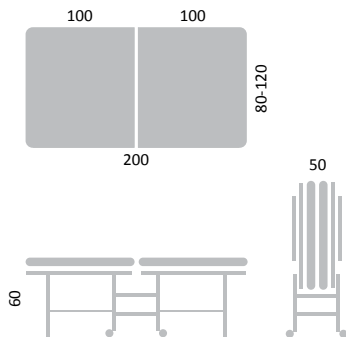

TECHNICAL PARAMETERS

Basic design of the JORDAN E line of couches

	E1	E2	E box
dimensions, length x standard width (width as required 80 - 120 cm)	200 x 100	200 x 100	200 x 100
number of cushioned segments	1	2	2
head end adjustable by gas strut	-	yes	-
electric height adjustment (cm)	50 - 105	50 - 105	-
fixed height (cm)	-	-	as required
manually adjustable height	yes	yes	-
mobile, Ø 70 mm castors with brake	-	-	yes

Optional accessories:

reduced minimum width height (cm)	45 - 92	45 - 92	-
castors - diameter 70 mm or 100 mm	•	•	-
fixation pins - shoulder, between legs	•	•	-
mouth opening in bolster with cover	-	•	-
electric foot control unit	•	•	-
RAL or chrome electric built-in control unit	•	•	-
sanitary paper holder behind head end	•	•	-
RAL or chrome side bars for fixation belts	•	•	-
euro-bar along bed side	•	•	-
fixation hinge for stainless steel Euro-track, tilting universal	•	•	-
safety switch-off cabinet	•	•	-

x basic design

• extra orders possible

- not available

JORDAN traction and tilting couches, line ME and C



JORDAN traction couches – ME line - single-actuator couch with electric height adjustment and couch tilt of up to 60°.

The bed is delivered with a suspension cross. These beds are suitable for spa bath houses, welfare centres and physiotherapeutic centres as well as for specialist doctor surgeries.

JORDAN tilting beds – C line - double-actuator bed with electric height adjustment and bed tilt of up to 90°.

The vertical position is controlled by a manual electric control unit; the height is adjusted by two foot controls on each side of the bed. The beds include an ascending step and arm rests with a panel.

These beds are suitable in particular for hospitals and physiotherapy centres.

JORDAN ME2

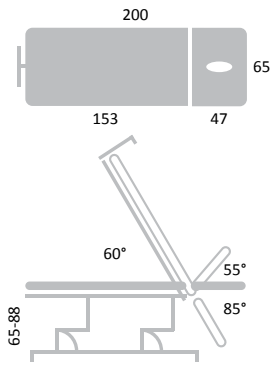

JORDAN C1

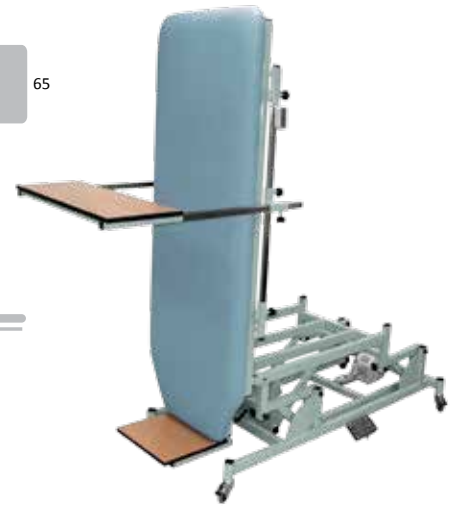
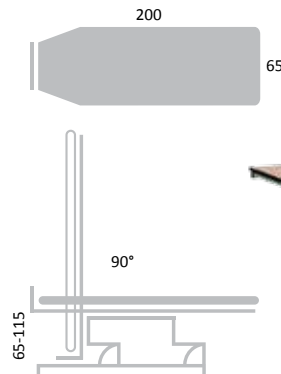

JORDAN ME3

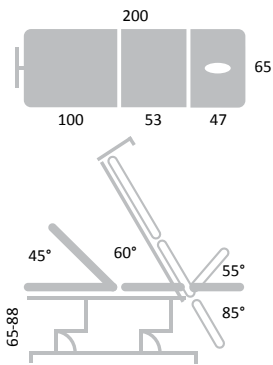

JORDAN C2

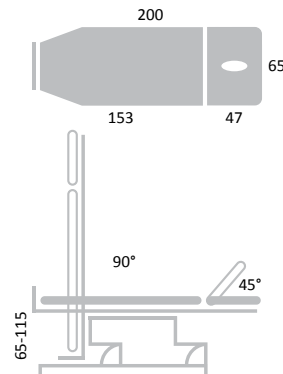

TECHNICAL PARAMETERS

Basic design of the JORDAN ME and C line of couches

	ME2	ME3	C1	C2
dimensions, length x width (cm)	200 x 65	200 x 65	200 x 65	200 x 65
number of cushioned segments	2	3	1	2
mouth opening in bolster with cover	yes	yes	•	yes
head end adjustable by gas strut	yes	yes	-	yes
leg position adjustable by gas strut	-	yes	-	-
electric tilting	0° - 60°	0° - 60°	0° - 90°	0° - 90°
electric height adjustment (cm)	65 - 88	65 - 88	65 - 115	65 - 115
manual control unit of height adjustment actuator	yes	yes	yes	yes
two foot control units for the actuator lift	•	•	yes	yes
side bars for fixation belts	•	•	yes	yes
castors - diameter 70 mm	•	•	with brake	with brake
suspension cross for a set of traction hinges	yes	yes	•	-
headrest with board (table)	-	-	•	•
Optional accessories:				
castors - diameter 70 mm or 100 mm	•	•	x	x
fixation pins - shoulder, between legs	•	•	•	•
electric foot control unit	•	•	x	x
RAL or chrome electric built-in control unit	•	•	-	-
sanitary paper holder behind head end	•	•	•	•
RAL or chrome side bars for fixation belts	•	•	x	x
euro-bar along bed side	•	•	-	-
fixation hinge for stainless steel Euro-track, tilting universal	•	•	-	-
set of traction hinges	•	•	•	•
fixation slider on the bar	-	-	•	•
fixation belt	-	-	•	•
safety switch-off cabinet	•	•	•	•

x basic design

• extra orders possible

- not available

JORDAN special couches



We have designed special couches in cooperation with specialists, physiotherapists and our experts to meet their special requirements and needs.

The individual models have been introduced to our product portfolio and we can offer them to you.

JORDAN Simple 2

JORDAN Simple 3

Single-actuator physiotherapeutic couch of simple construction with electric height adjustment. The beds are suitable for classic massages, as examination tables for surgeries and for simple exercises with a physiotherapist.

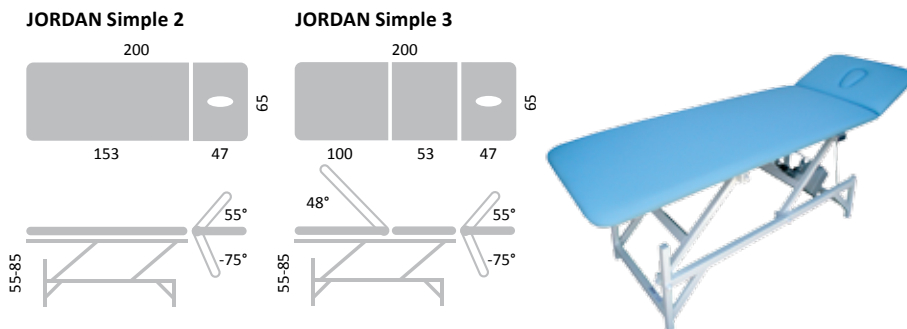

JORDAN Prima 3

Single-actuator physiotherapeutic couch with electric height adjustment. The beds are suitable for classic massages, as examination tables for surgeries and for simple exercises with a physiotherapist.

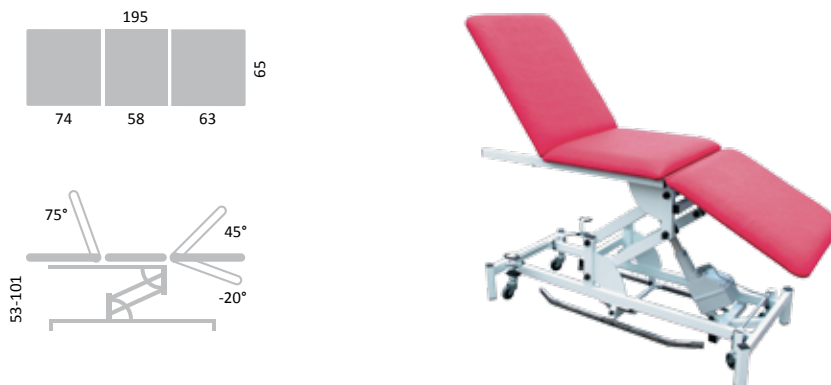

JORDAN M6 osteo

Double-actuator osteopathic couch with electric height adjustment and bed tilting. The bed is designed for osteopathic procedures.

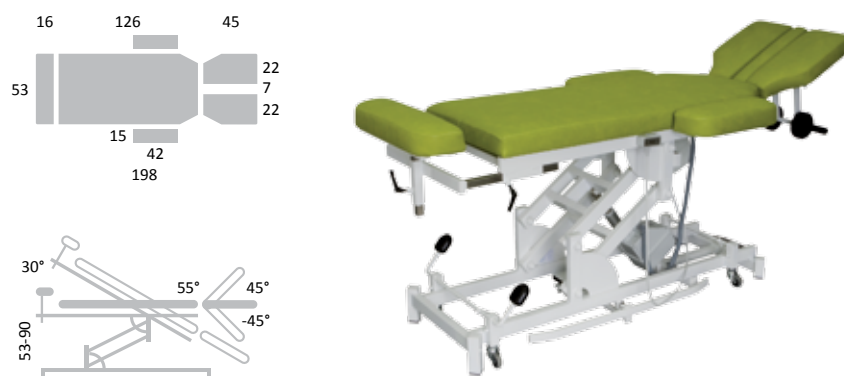

TECHNICAL PARAMETERS

Basic design of the JORDAN special line of couches	Simple 2	Simple 3	Prima 3	M6 osteo
dimensions, length x width (cm)	200 x 65	200 x 65	195 x 65	190 x 53
number of cushioned segments	2	3	3	6
electric tilting	-	-	-	yes
electric height adjustment (cm)	55 - 85	55 - 85	53 - 101	53 - 90
manually adjustable height	yes	yes	yes	yes
3-part head bolster	•	•	-	yes
mouth opening in bolster with cover	yes	yes	-	-
adjustable face opening	-	-	-	yes
head end adjustable by gas strut.	yes	yes	yes	yes
leg position adjustable by gas strut	-	yes	yes	-
folding side armrests along the central section	-	-	-	yes
mechanically adjustable leg rest	-	-	-	yes
Optional accessories:				
castors - diameter 70 mm or 100 mm	•	•	•	•
fixation pins - shoulder, between legs	•	•	•	•
conical narrowing at the foot end	-	-	•	-
conical narrowing at the head end	-	-	•	-
electric foot control unit	•	•	•	•
RAL or chrome electric built-in control unit	•	•	•	•
extended bed width over 80 cm inclusive	•	•	•	-
sanitary paper holder behind head end	•	•	•	•
RAL or chrome side bars for fixation belts	-	-	-	•
euro-bar along bed side	-	-	-	•
fixation hinge for stainless steel Euro-track, tilting universal	-	-	-	•
additional folding rests along the central part of the couch	•	•	•	•
safety switch-off cabinet	•	•	•	•

x basic design

• extra orders possible

- not available

JORDAN A transport

Acuator-free transport couch (stretcher) with a fixed bed height. Suitable for transport of patients.

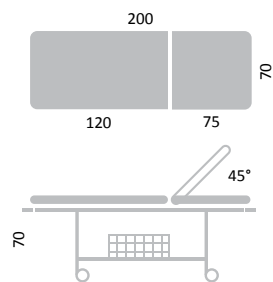

JORDAN Hospital

Transport chair with two-part adjustable hydraulic foot lever. Suitable for hospitals to transport patients.

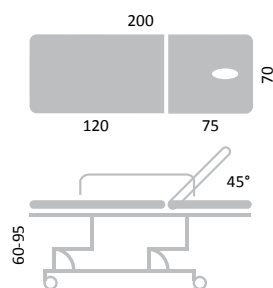

JORDAN F7 CM

Single-actuator transport couch (stretcher) with electric height adjustment, designed for special physiotherapy.

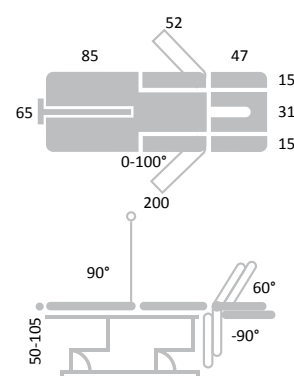

TECHNICAL PARAMETERS

Basic design of the JORDAN special line of couches

	A transport	Hospital	F7 CM
dimensions, length x width (cm)	195 x 65	200 x 70	200 x 65
external length x clearance width	205 x 72	207 x 77	-
number of cushioned segments	2	2	7
electric height adjustment (cm)	-	-	50 - 105
height adjustment lever hydraulic foot (cm)	-	60 - 95	-
fixed height, alteration at no extra charge (cm)	70	-	-
electric foot control unit	-	-	yes
mouth opening with cover	-	yes	-
head end adjustable by a system of tightening levers	yes	-	-
head end adjustable by gas strut	-	-	yes
backrest adjustable by gas strut	-	yes (2pc)	-
leg position adjustable by gas strut	-	yes	-
ø 125 mm castors with possibility of blocking the left front	-	yes	-
central castor control	-	yes	-
ø 150 mm castors, full brakes, 1pc of straight direction blocking	yes	-	-
stacking wire basket	yes	-	-
rotating plastic bumpers	yes	-	-
bumper castors - diameter 70 mm	-	yes	-
folding side armrests along the central section	-	-	yes
sliding side armrests along the central section	-	-	yes
centrally pre-adjustable footrest	-	-	yes
Optional accessories:			
castors - diameter 70 mm or 100 mm	-	-	•
RAL or chrome electric built-in control unit	-	•	-
sanitary paper holder behind head end	•	•	•
foldable side bars	•	•	-
infusion stand and stand holder	•	•	•
fixation belts	-	•	-
storage area for scans	-	•	-
oxygen cylinder holder	-	•	-
RAL or chrome side bars for fixation belts	-	-	•
euro-bar along bed side	-	-	•
fixation hinge for stainless steel Euro-track, tilting universal	-	-	•
safety switch-off cabinet	-	•	•

x basic design

• extra orders possible

- not available

JORDAN U7 plastik

Single-actuator bed with electric height adjustment, specially designed for plastic surgeries, enabling a second actuator for electric adjustment to be fixed to backrest for sitting.

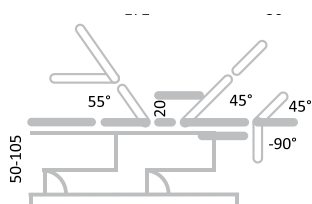
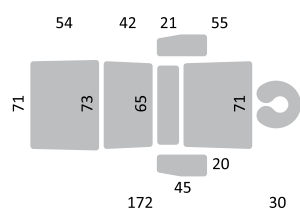

JORDAN T3 transfuze

Single-actuator transfusion couch with electric height adjustment.

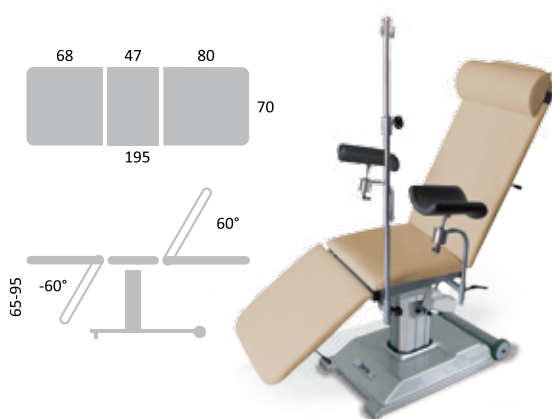

JORDAN T3 transfuze simple

Actuator-free transfusion chair with a fixed height.



TECHNICAL PARAMETERS

Basic design of the JORDAN special line of couches	U7 plastik	T3 transfuze	T3 transfuze simple
dimensions, length x width (cm)	172 x 71	195 x 70	195 x 65
number of cushioned segments	7	3	3
electric height adjustment (cm)	50 - 105	65 - 95	-
fixed height, alteration at no extra charge (cm)	-	-	60
manually adjustable height	yes	yes	-
removable head end	yes	-	-
backrest adjustable by gas strut	-	-	yes
backrest adjustable by actuator	yes	yes	-
leg position adjustable by gas strut	yes	-	yes
leg position adjustable by actuator	•	yes	-
adjustable height, removable arm rests	yes	-	-
removable arm rests	-	yes	yes
Optional accessories:			
castors - diameter 70 mm or 100 mm	•	-	-
electric foot control unit	•	•	-
RAL or chrome electric built-in control unit	•	-	-
electric backrest	•	-	-
sanitary paper holder behind head end	•	•	•
infusion stand and stand holder	-	•	•
RAL or chrome side bars for fixation belts	•	-	-
euro-bar along bed side	•	-	-
fixation hinge for stainless steel Euro-track, tilting universal	•	-	-
auxiliary ascending step	-	•	•
safety switch-off cabinet	•	-	-

x basic design

• extra orders possible

- not available

JORDAN wooden couches

Single-motor wooden massage tables suitable for surgeries, wellness centres and beauty studios. The construction is made of dark or light ash. The four centimetre upholstery and flexible bolster guarantees great comfort for the patient.

JORDAN HENRY

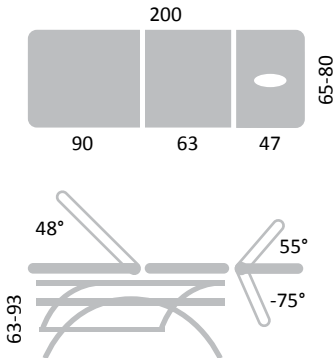

JORDAN MARY

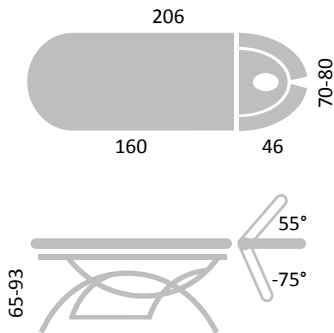

Height adjustment



Foot-end tilt



Each part of the construction is made of one piece of wood



3-teiliges Ohrkissen

TECHNICAL PARAMETERS

Basic design of the JORDAN wooden couches

	HENRY	MARY
dimensions, length x width (cm)	200 x 65-80	206 x 70-80
number of cushioned segments	3	4
3-part head bolster	•	yes
mouth opening in bolster with cover	yes	yes
head position adjustable	yes	yes
leg position adjustable	yes	-
electric height adjustment (cm)	63 - 93	65 - 93
Hand or foot-operated electric	yes	yes
thicker 4 cm base	yes	-
Optional accessories:		
3-part head bolster	•	x
roof position	•	-
foot-end as support	•	-
set of castors	•	-
second leg control	•	-
side arm supports	•	-
thicker 6 cm base	•	x

x basic design

• extra orders possible

- not available

Untypical JORDAN couch modifications

We offer untypical design modifications of our Jordan couches after consultation. Optional constructions are possible, untypical upholstery, changes in couch width etc.

Beta construction version



Perfect type of construction control. Adjustable height 48 - 95 cm.

These constructions can be applied to models F2, F3, F4, F5 G3 and G5.

Column construction version

Höhenverstellung 60 - 100 cm.



Untypical upholstery



Untypical design of side supports and three-section bolster possible.



Cardio hole in the bolster with a cover.

Hygienic mats and disinfectants



Single-use hygienic protective mats

These mats consist of two layers of pulp enabling perfect absorption of liquids and polyethylene film which prevents saturation. They come in 33, 38 and 51 cm widths. Perforation at distances of 50, 80 and 160 cm used to tear the mat. We supply the mats in the following colour versions: green, blue, yellow, apricot, lilac, pink and white.



Disinfectants

We recommend only INCIDIN LIQUID disinfectants tested by us for the couches and tables. We supply them in 1 l or 5l containers. An appropriate way of applying the disinfectant is to use a mechanical pump or sprayer.

Optional accessories for JORDAN couches



castors – diameter 70 mm



castors – diameter 100 mm



manually adjustable height



electric foot control unit



castor with brake



safety switch-off cabinet



electric built-in control unit



sanitary paper holder



Options of mouth openings with cover



Options of mouth openings with cover



Options of mouth openings with cover



Options of mouth openings with cover



3-part head bolster

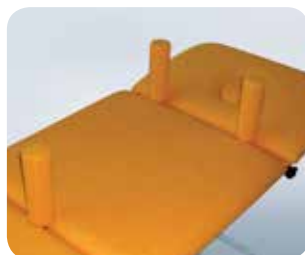

fixation pins - shoulder, between legs



extended bed width



conical narrowing



additional folding rests



infusion stand



foldable side bars



Rostomat system

Colours chart for JORDAN couches

Pattern chart of artificial leather cushioning



Frame color chart

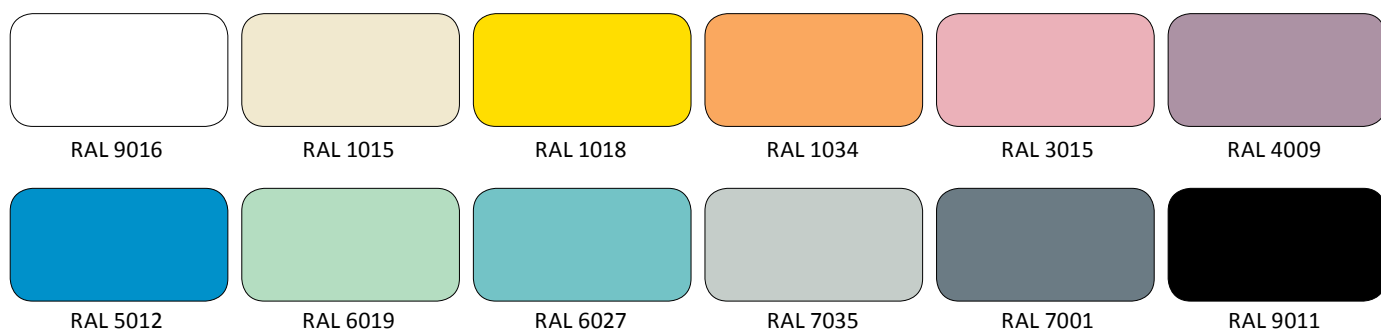

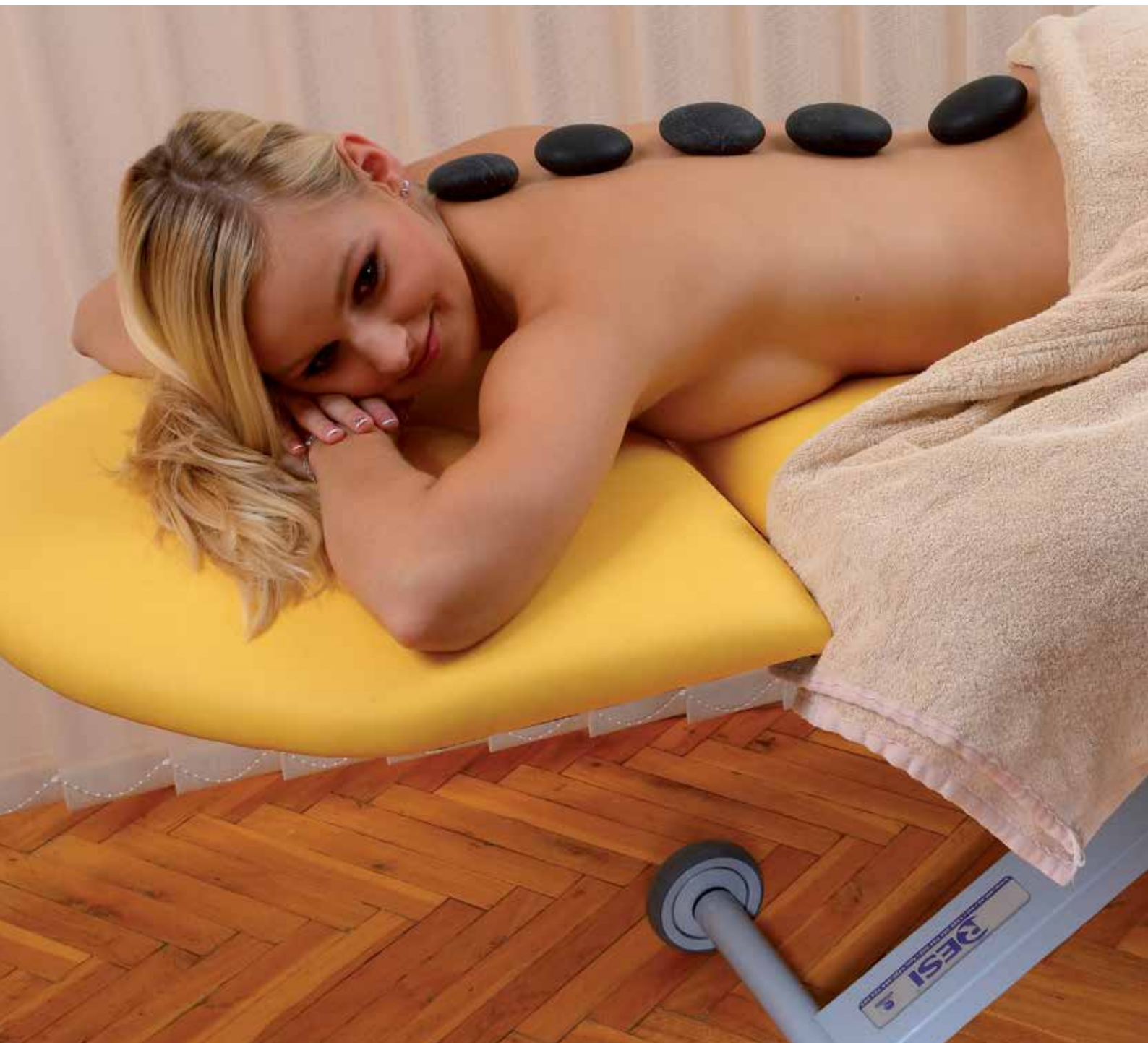

RESI[®]
www.resi.cz

RESI Třeboň spol. s r. o.
Novohradská 1153
379 01 Třeboň, Czech Republic
Tel.: +420 384 724 292
Fax: +420 384 724 293